

## Cuba 620

### CUBA COLLECTION:

Cuba 620, Cuba 621, Cuba 622, Cuba 623,

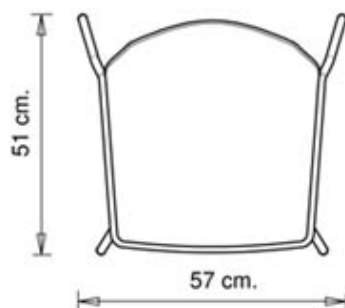
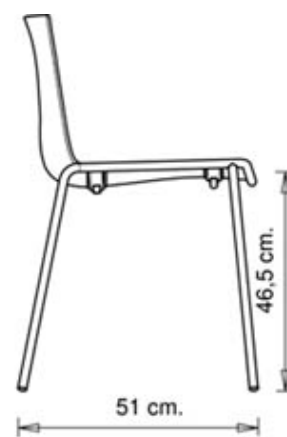
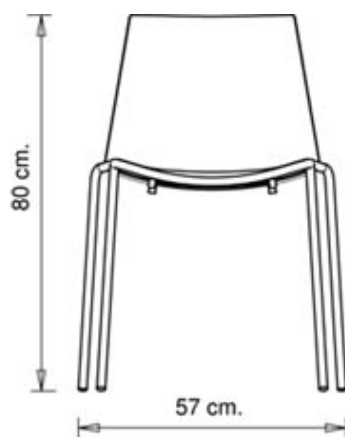

Chair with steel frame, 4 legs. Polypropylene shell.

#### STACKABLE

4

#### WEIGHT

5,8 Kg

#### PACK

0,36 m<sup>3</sup>

#### PIECES PER BOX

4

### FINISHES SEATING

PP POLYPROPYLENE 



RAL 9010 Pure white



RAL 7000 Squirrel grey

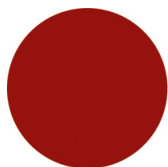

RAL 3003 Ruby red



RAL 9005 Jet black



NCS S3010-G30Y  
Pistachio

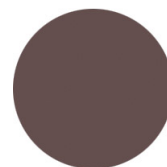

PANTONE 411 C Clay



## FRAMES

### AC STEEL



RAL 9016  
VR Traffic white



RAL 9010  
VR Pure white

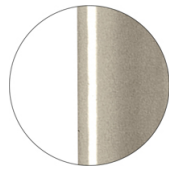

PANTONE 402 C  
VR Turtle-dove

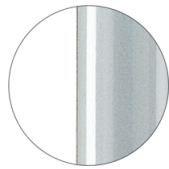

RAL 9006  
VR White aluminium

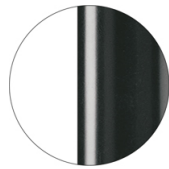

RAL 7016  
VR Anthracite grey

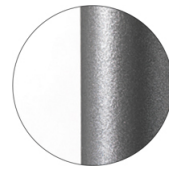

VR Pewter

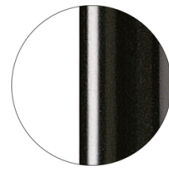

RAL 9005  
VR Jet black

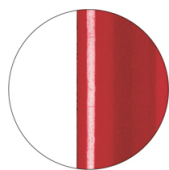

RAL 3003  
VR Ruby red

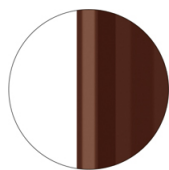

RAL 8017  
VR Chocolate brown

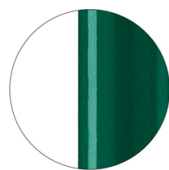

RAL 6005  
VR Moss green

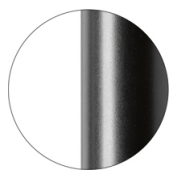

RAL 9005  
VR Matt Jet Black

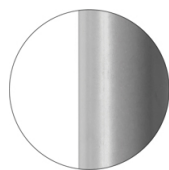

RAL 7037  
VR Matt Dusty grey

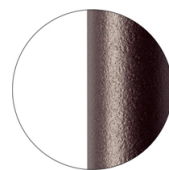

VR Rough metallic  
bronze



CR Chrome

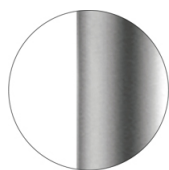

CR S Satin chrome

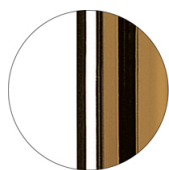

CR X Brass chrome

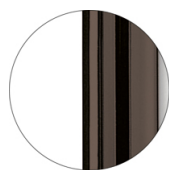

CR X Burnished chrome

## USES

coffee & restaurants, entertainment, retail, outdoor,

## Cuba 621

CUBA COLLECTION:  
Cuba 620, Cuba 621, Cuba 622, Cuba 623,

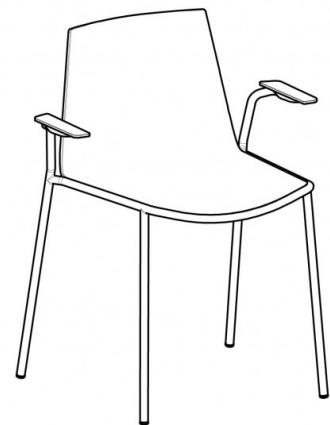
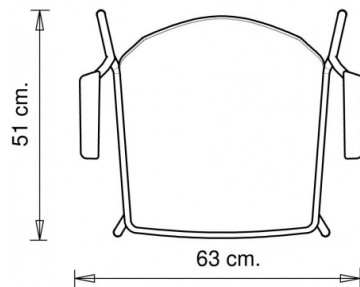
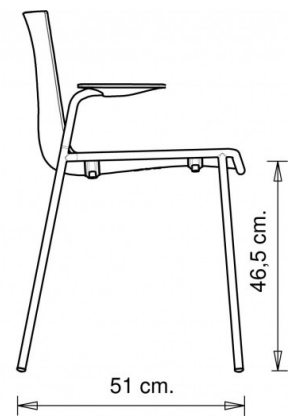
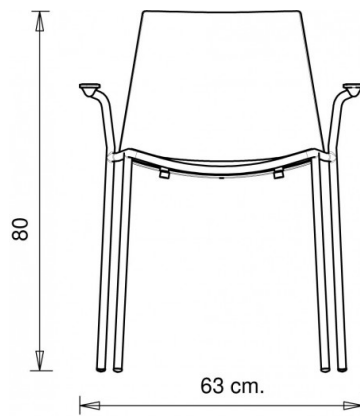

Chair with armrests and steel frame, 4 legs.  
Polypropylene shell.

**STACKABLE**

4

**WEIGHT**

6,2 Kg

**PACK**

0,40

**PIECES PER BOX**

4

## FINISHES SEATING

**PP POLYPROPYLENE** 



RAL 9010 Pure white  
≡



RAL 7000 Squirrel grey  
≡

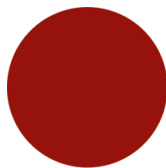

RAL 3003 Ruby red  
≡

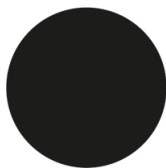

RAL 9005 Jet black  
≡



NCS S3010-G30Y  
Pistachio  
≡

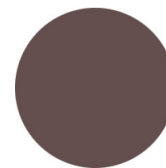

PANTONE 411 C Clay  
≡

## FRAMES

### AC STEEL



RAL 9016  
VR Traffic white  
☀



RAL 9010  
VR Pure white  
☀

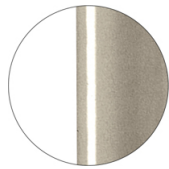

PANTONE 402 C  
VR Turtle-dove  
☀

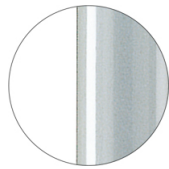

RAL 9006  
VR White aluminium  
☀

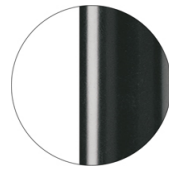

RAL 7016  
VR Anthracite grey  
☀

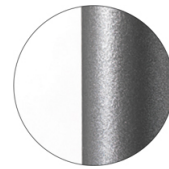

VR Pewter  
☀

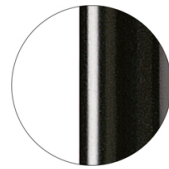

RAL 9005  
VR Jet black  
☀

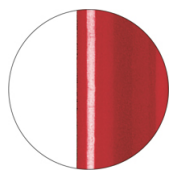

RAL 3003  
VR Ruby red  
☀

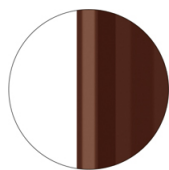

RAL 8017  
VR Chocolate brown  
☀

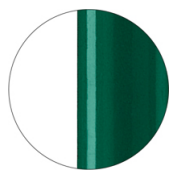

RAL 6005  
VR Moss green  
☀

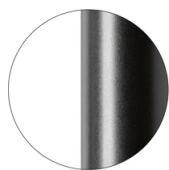

RAL 9005  
VR Matt Jet Black  
☀

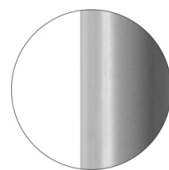

RAL 7037  
VR Matt Dusty grey  
☀

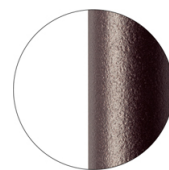

VR Rough metallic  
bronze  
☀



CR Chrome

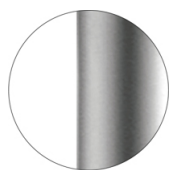

CR S Satin chrome

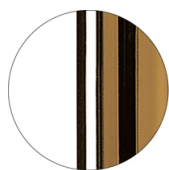

CR X Brass chrome

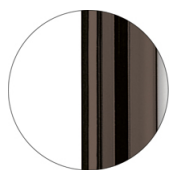

CR X Burnished chrome

## USES

coffee & restaurants, entertainment, retail, outdoor,

## Cuba 622

CUBA COLLECTION:  
Cuba 620, Cuba 621, Cuba 622, Cuba  
623,

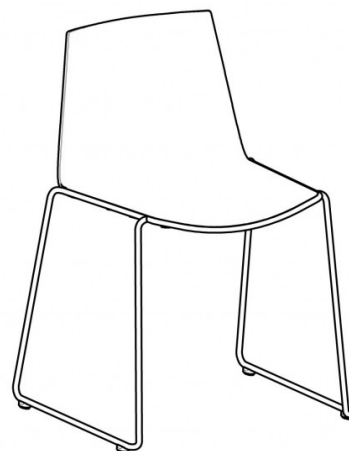
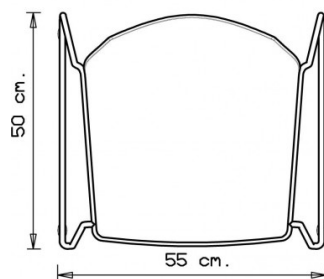
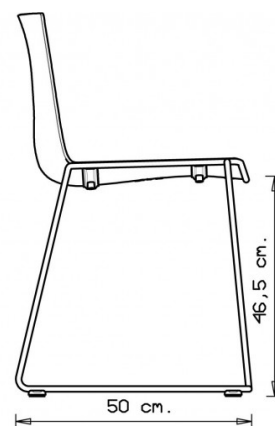
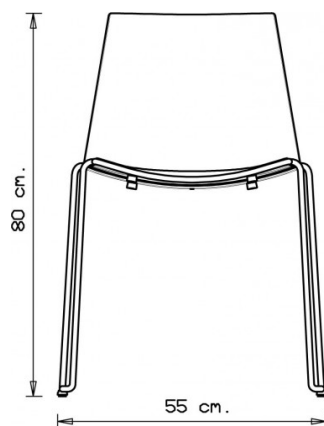

Chair with sled steel frame. Polypropylene shell.

**STACKABLE**

6

**WEIGHT**

7 Kg

**PACK**

0,36 m<sup>3</sup>

**PIECES PER BOX**

4

## FINISHES SEATING

**PP POLYPROPYLENE** 



RAL 9010 Pure white



RAL 7000 Squirrel grey

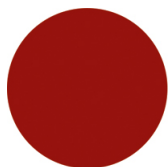

RAL 3003 Ruby red



RAL 9005 Jet black



NCS S3010-G30Y  
Pistachio

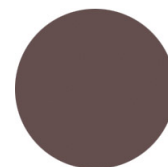

PANTONE 411 C Clay



## FRAMES

### AC STEEL



RAL 9016  
VR Traffic white  
☀



RAL 9010  
VR Pure white  
☀

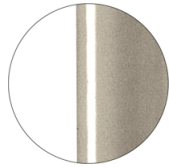

PANTONE 402 C  
VR Turtle-dove  
☀

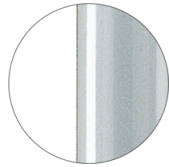

RAL 9006  
VR White aluminium  
☀

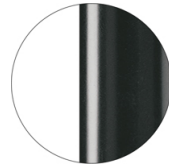

RAL 7016  
VR Anthracite grey  
☀

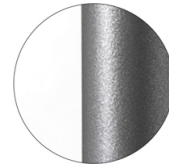

VR Pewter  
☀

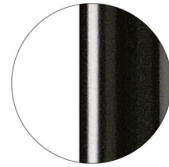

RAL 9005  
VR Jet black  
☀

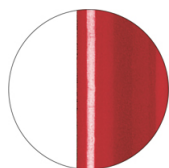

RAL 3003  
VR Ruby red  
☀

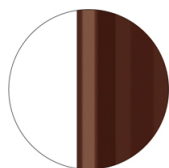

RAL 8017  
VR Chocolate brown  
☀



RAL 6005  
VR Moss green  
☀

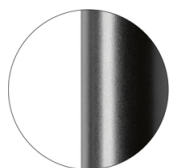

RAL 9005  
VR Matt Jet Black  
☀

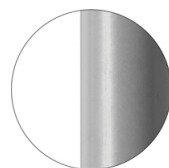

RAL 7037  
VR Matt Dusty grey  
☀

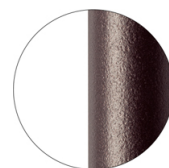

VR Rough metallic  
bronze  
☀

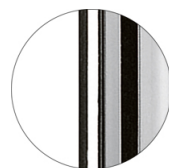

CR Chrome

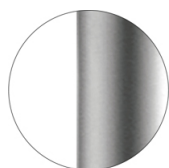

CR S Satin chrome



CR X Brass chrome

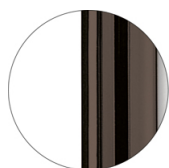

CR X Burnished chrome

## USES

coffee & restaurants, entertainment, retail, outdoor,

## Cuba 623

CUBA COLLECTION:  
Cuba 620, Cuba 621, Cuba 622, Cuba  
623,

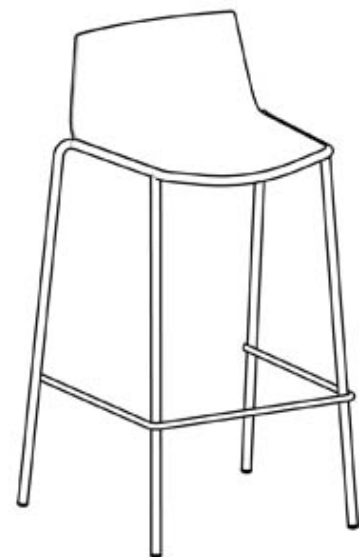
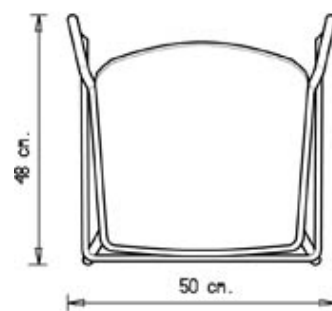
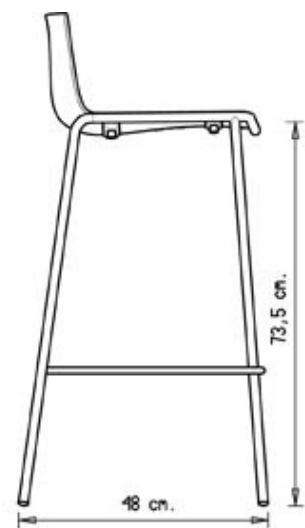
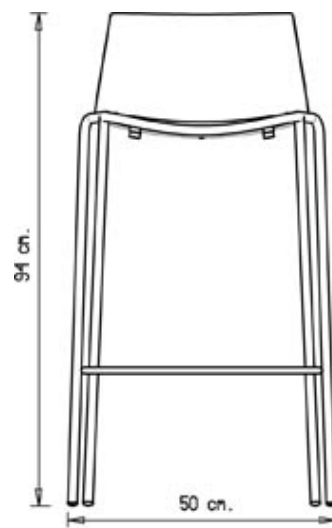

Barstool with steel frame, 4 legs. Polypropylene seat.

**STACKABLE**

4

**WEIGHT**

6,4 Kg

**PACK**

0,29 m<sup>3</sup>

**PIECES PER BOX**

4

## FINISHES SEATING

**PP POLYPROPYLENE** 



RAL 9010 Pure white



RAL 7000 Squirrel grey

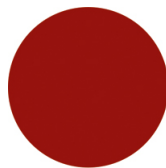

RAL 3003 Ruby red

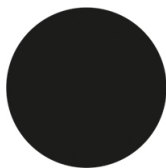

RAL 9005 Jet black



NCS S3010-G30Y  
Pistachio

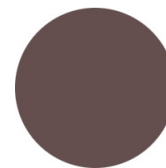

PANTONE 411 C Clay



## FRAMES

### AC STEEL



RAL 9016  
VR Traffic white



RAL 9010  
VR Pure white

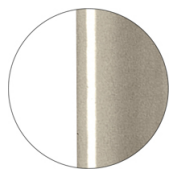

PANTONE 402 C  
VR Turtle-dove

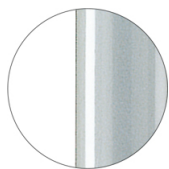

RAL 9006  
VR White aluminium

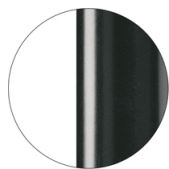

RAL 7016  
VR Anthracite grey

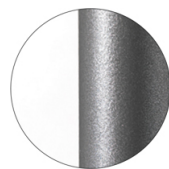

VR Pewter

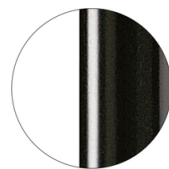

RAL 9005  
VR Jet black

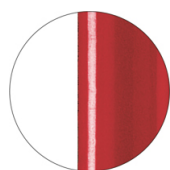

RAL 3003  
VR Ruby red

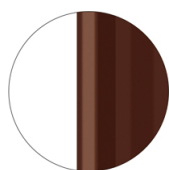

RAL 8017  
VR Chocolate brown

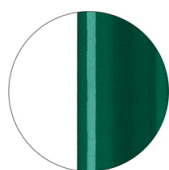

RAL 6005  
VR Moss green

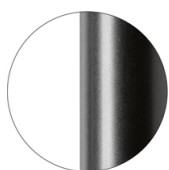

RAL 9005  
VR Matt Jet Black

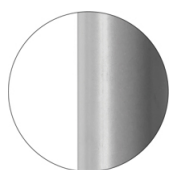

RAL 7037  
VR Matt Dusty grey

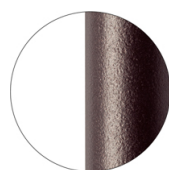

VR Rough metallic  
bronze



CR Chrome

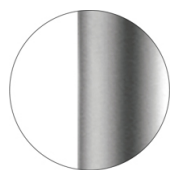

CR S Satin chrome

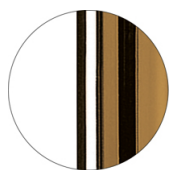

CR X Brass chrome

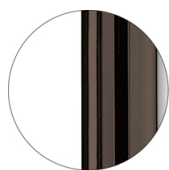

CR X Burnished chrome

## USES

coffee & restaurants, entertainment, retail, outdoor,