

Rdm

## Filoline 001

FILOLINE COLLECTION:  
Filoline 001,

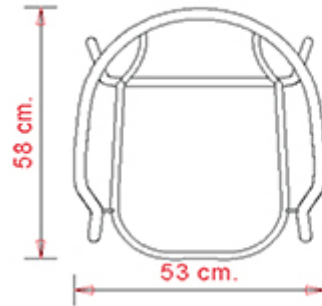
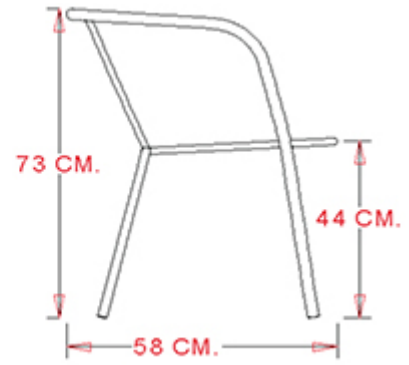

Armchair with 4 legs steel frame. Seat and back in Xiloplast (wire with steel soul).

**STACKABLE**

8

**WEIGHT**

5,5 kg

**PACK**

0,32 m<sup>3</sup>

**PIECES PER BOX**

4

## FINISHES SEATING

### XLP XILOPLAST



Green 29

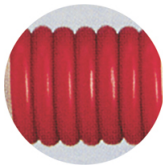

Red 6



Black 1



Havana 24



White

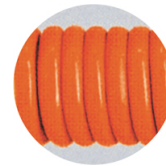

Orange 16

## FRAMES

### AC STEEL



RAL 9016  
VR Traffic white



RAL 9010  
VR Pure white

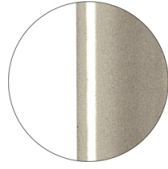

PANTONE 402 C  
VR Turtle-dove

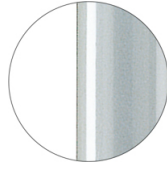

RAL 9006  
VR White aluminium

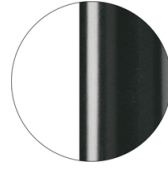

RAL 7016  
VR Anthracite grey

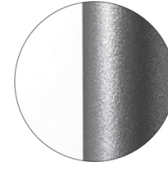

VR Pewter

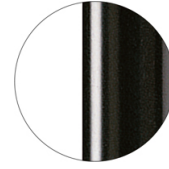

RAL 9005  
VR Jet black

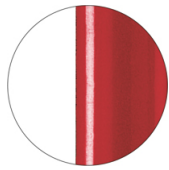

RAL 3003  
VR Ruby red



RAL 8017  
VR Chocolate brown

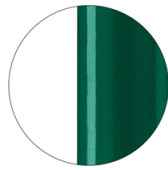

RAL 6005  
VR Moss green

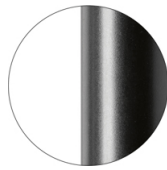

RAL 9005  
VR Matt Jet Black

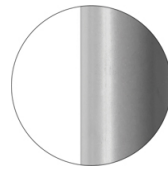

RAL 7037  
VR Matt Dusty grey

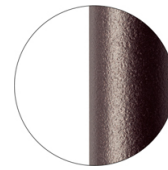

VR Rough metallic  
bronze



CR Chrome

## CERTIFICATIONS

> UNI 8584:1984 - Resistenza a fatica della struttura: 5 (20/08/98)

## USES

coffee & restaurants, hotels, educational, entertainment,